

Dedicated C&I / Utility ESS



Self-Consumption



Demand Charge



Micro-grid



EV charge Station



Frequency Integration



Off Grid



V2G



Back Up



Peak Shifting



Renewable Regulation



Battery

storage systems have been proven to be “extremely lucrative” for commercial and industrial (C&I) field.

“ MAXIMUM SAFETY FOR YOUR ENERGY

Providing a continuous and reliable supply of power from a flexible mix of conventional and renewable sources is the goal of power generation in the energy evolution.

C&I/Utility ESS Key Features



Vertical industry Integration Chain



Three-levels monitoring and management mechanism design



Optimal Electricity Long cycle life and superior performance



Rack mounted or container based system configuration

UL9540A Test Summary

- Target BESS temperature less than gas vent temperature
- Temperature increase of target walls less than 97 °C(175 °F)
- The flame indicator shall not propagate flames beyond the width of initiating BESS
- No flaming outside the test room

..... Certification





Power Distribution

Back Up

Battery energy storage system (BESS) serves as ideal back-up for instant power supply, Seamless Switch to off grid mode in the very short time and realize the Uninterruptible power supply.

How it benefit?

Avoid devices stop working and reduce economic losses once outage or disconnection from the grid.

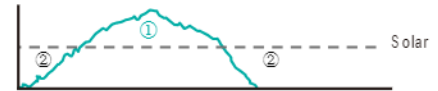
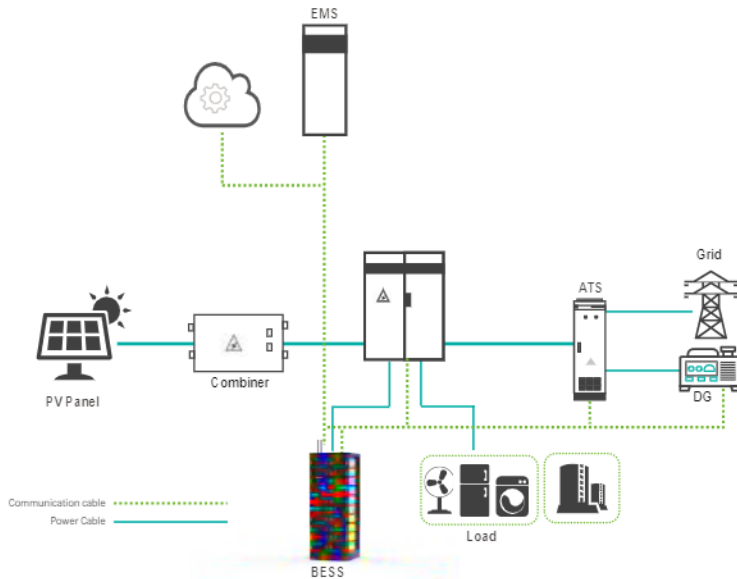

① When solar is sufficient, solar charge the battery and power battery.
② When the solar is weak, Battery power the load.



When grid fails or cloudy day, battery power the load.



When battery in low mode, DG start to power the load.



Continuous Power to the load

EV Charge Station/V2G

Uncontrolled charging demand in an electric vehicle charging station (EVCS) can potentially result in the overloading of the grid coupling transformer and affect the transformer's lifetime. BESS in PV integrated EV charging station for reducing transformer overloading and providing battery-to-grid service

How it benefit?

Delay the investment of grid structure.

Reduce transformer overloading and PV smoothing within battery SOC constraints.

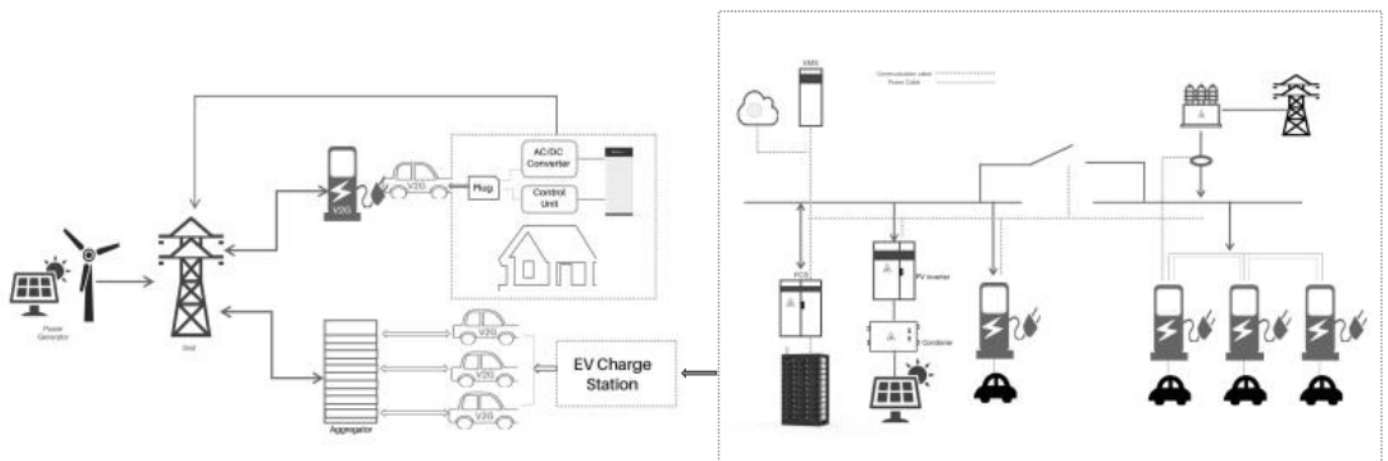

Micro-grid

A microgrid is a self-sufficient energy system that serves a discrete geographic footprint, such as a college campus, hospital complex, business center, rural areas, shop or island use.

How it benefit?

- Operate independently
- Avoid high cost to expand a grid connection
- Save electric bill

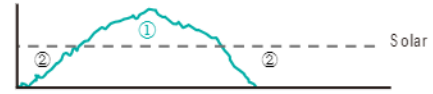
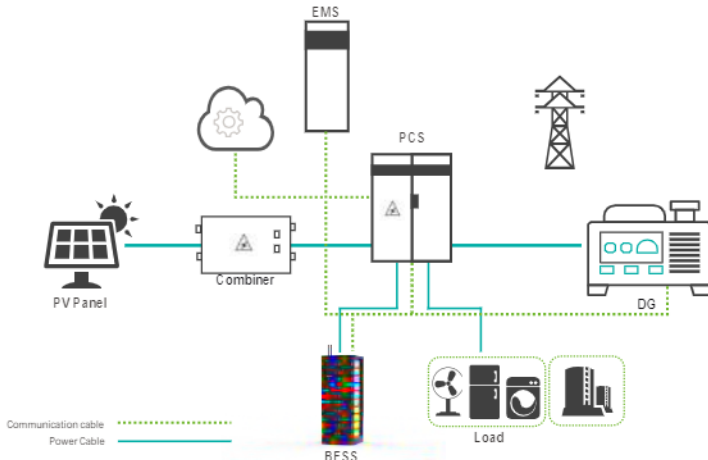

- ① When solar is sufficient, solar charge the battery and power the load.
- ② When the solar is weak, solar and battery power the load.



When at night or cloudy day, battery power the load.



When battery in low mode, DG start to power the load.



Continuous Power to the load

Large-Scale Off grid

Solar plus storage system will be the main power source to produce and store energy for rural and remote off-grid area. DG as backup to support daily consumption.

How it benefit?

- Safe, low-maintenance power supply
- Reduce fuel cost and air pollution
- Reliable supply without a grid connection

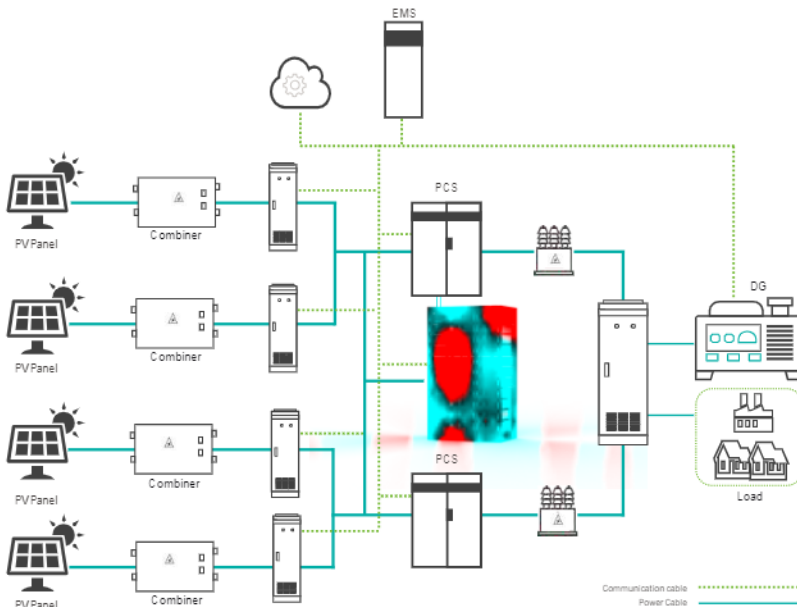

- ① When solar is sufficient, solar charge the battery and power load.
- ② When the solar is weak, solar and battery power the load.



When at night or cloudy day, battery power the load.



Continuous Power to the load

Peak Shifting

With purpose of reducing peak demand and economy of operation, compensate local transformer limit.

How it benefit?

Save on their electricity bills by reducing peak demand ([Commercial and industrial customers](#))

Reduce the operational cost of generating power during peak periods ([Utilities](#))

Investment in infrastructure is delayed due to the flatter loads with smaller peaks ([Owner](#))

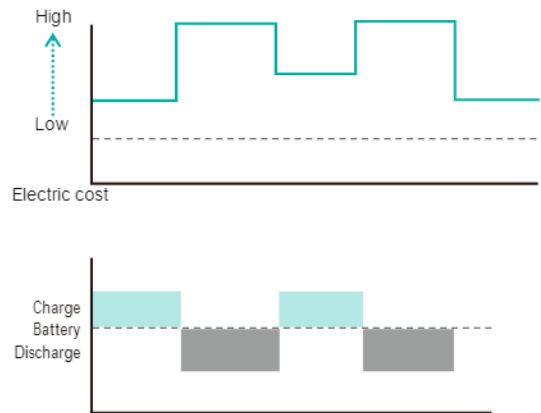
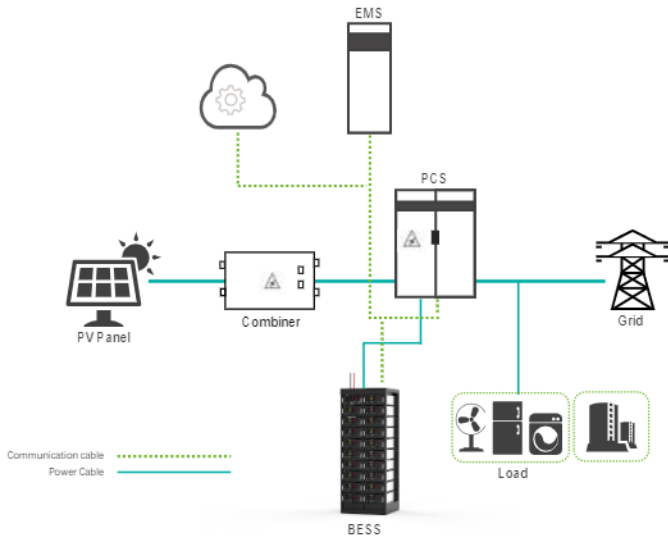

Frequency regulation

BEES will be imperative to ensure that frequency regulating services can be provided when required and meet the charge/discharge requirements imposed on assets providing enhanced frequency response.

How it benefit?

Reduce the investment of power generation, save cost

Constant balancing act to manage system frequency stability.

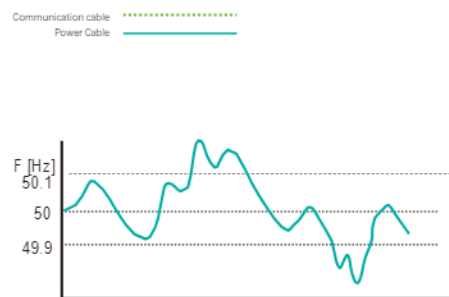
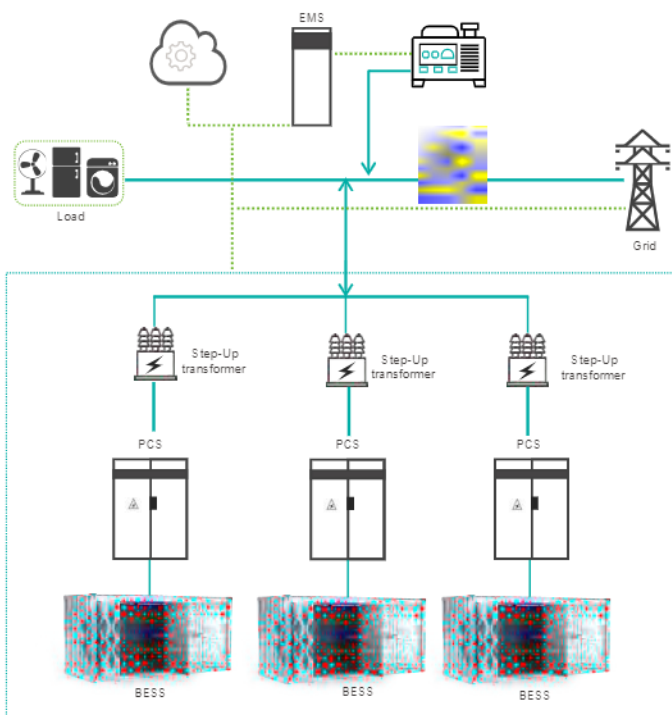

Charge the battery quickly from grid when the energy is abundant, Discharge when the energy is less available, keep regular frequency.

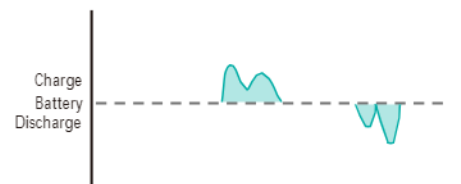

Power Generator

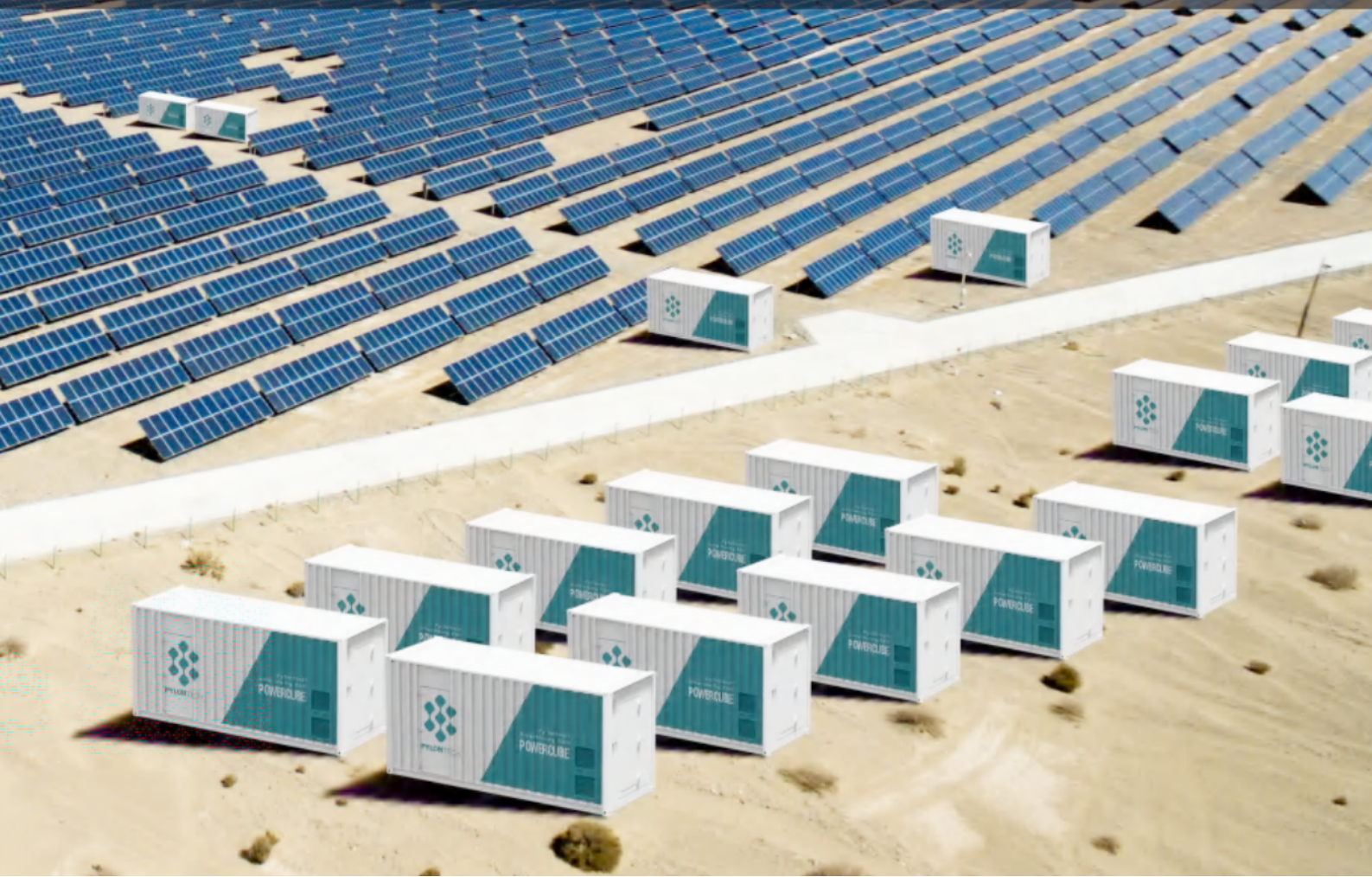

Grid Service

BESS will be imperative to ensure that frequency regulating services can be provided when required and meet the charge/discharge requirements imposed on assets providing enhanced frequency response.

How it benefit?

Reduce the investment of power generation, save cost
Constant balancing act to manage system frequency stability.

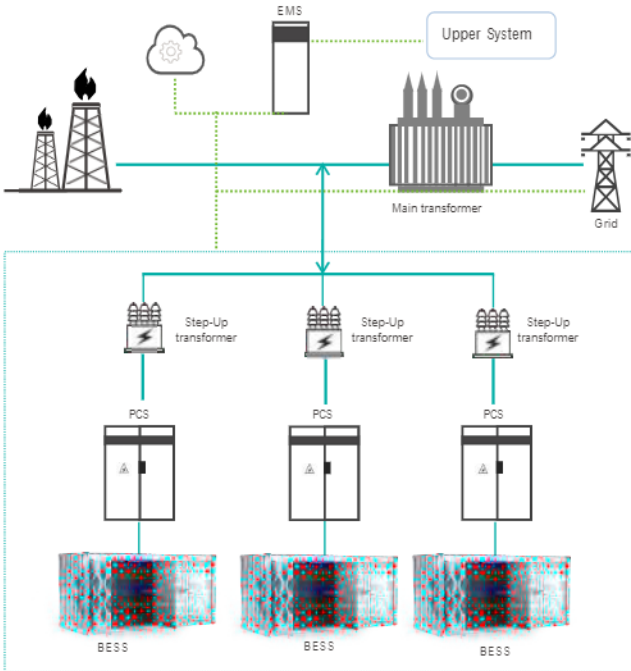

Communication cable
Power Cable

Sequence diagram



Charge battery from grid when the power is abundant, Discharge battery to compensate power of grid and keep regular frequency.

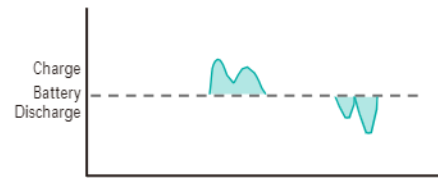

Renewable Integration

Storage helps smooth the power supply, enabling electricity to flow even when the sun isn't shining or the wind isn't blowing. It brings more reliability, more resiliency, and many of these systems can be used for voltage correction, and frequency response in the grid.

How it benefit?

Adding storage to distributed fixed-orientation PV is assumed to increase the capacity credit
Reduce grid investment for renewable energy connection
Reduce grid stress from renewable inrush

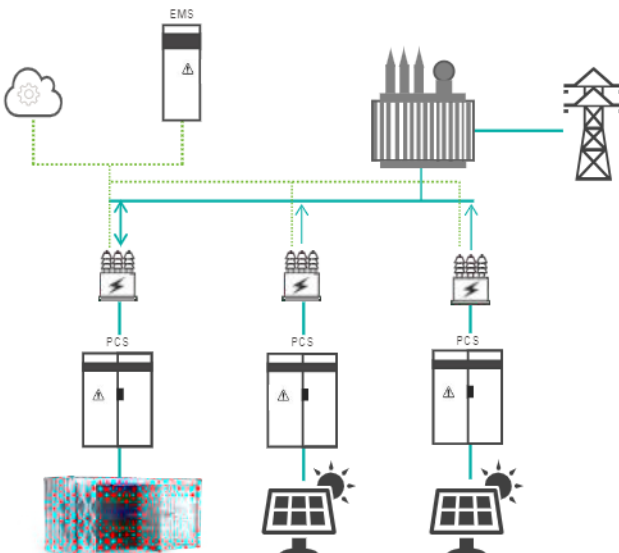

Communication cable
Power Cable

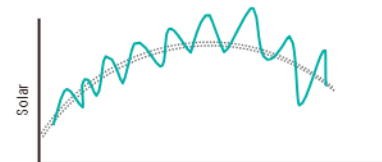

Charge battery from grid when the power is abundant, Discharge battery to compensate power of grid and keep regular frequency.

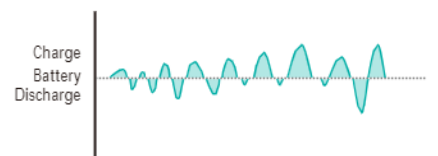

SPECIFICATION

Battery Module



Basic Parameters	H48050	H48074	H32148
Energy (kWh)	2.4	3.55	4.74
Nominal Voltage(V)	48	48	32
Battery Capacity(Ah)	50	74	148
Voltage range(V)	45~54	45~54	30~36
Dimension (W*D*H mm)	442*390*100	442*390*132	330*628*150.5
Weight(kg)	24	32	48

Powercube X series
100~600V

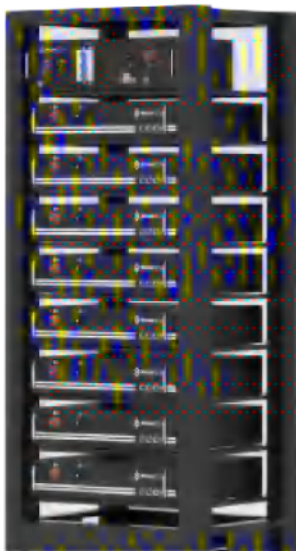

Basic Parameters	Powercube X1 (336V50Ah)	Powercube X2 (336V74Ah)
Battery Module	H48050	H48074
Battery System Capacity(kWh)	16.8	24.9
Battery system Voltage(V)	336	336
Battery System Voltage Range (V)	315~378	315~378
Efficiency(@0.5C-rate)	96%	96%
Depth of Discharge	95%	95%
Dimension (W*D*H mm)	600*505*1300	600*505*1380
Weight(kg)	275	330
Design Life	15+Years	15+Years
Operation Temperature ()	0~50	0~50
Humidity	5%~95%	5%~95%
Altitude	2000	2000
Battery Module Qty.(Optional)	2~10	2~10
Authentication level	IEC62619/VDE2510-50/UL1973/CE/CEC	

SPECIFICATION

Powercube H series
200~1000V

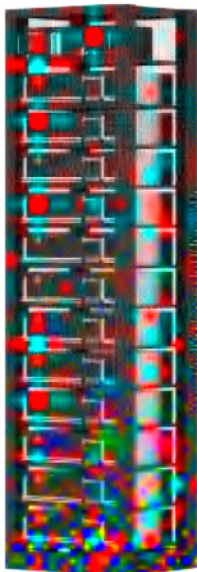

Basic Parameters	Powercube-H1 (720V50Ah)	Powercube-H2 (576V74Ah)
Battery Module	H48050	H48074
Battery System Capacity(kWh)	36	42.62
Battery system Voltage(V)	720	576
Battery System Voltage Range (V)	664~810	531~648
Efficiency(@0.5C-rate)	96%	96%
Depth of Discharge	95%	95%
Dimension (W*D*H mm)	600*505*2130	600*505*2130
Weight(kg)	400	450
Design Life	15+Years	15+Years
Operation Temperature (°C)	0~50	0~50
Humidity	5%~95%	5%~95%
Altitude	2000	2000
Battery Module Qty.(Optional)	5~15 pcs	5~12 pcs
Authentication level	IEC62619/VDE2510-50/ UL1973/CE/CEC	IEC62619/UL1973/CE

Powercube M1
100~1000V



Basic Parameters	Powercube-M1 (736V148Ah)
Battery Module	H32148
Battery System Capacity(kWh)	108.93
Battery system Voltage(V)	736
Battery System Voltage Range (V)	621~828
Efficiency(@0.5C-rate)	96%
Depth of Discharge	90%
Dimension (W*D*H mm)	815*659*2130
Weight(kg)	1250
Design Life	15+Years
Operation Temperature (°C)	10~40
Humidity	5%~95%
Altitude	2000
Battery Module Qty. (Optional)	1~23 pcs
Authentication level	IEC62619/IEC63056/UL1973/UL9540 A/VDE2510-50/CE/UN38.3

SPECIFICATION

Powercube M2
100~1000V



Basic Parameters	Powercube-M2A-180 (729.6V148Ah)
Battery System Capacity(kWh)	107.98
Battery Module	HM2A180
Battery system Voltage(V)	729.6
Battery System Voltage Range (V)	615.6~820.8
Efficiency(@0.5C-rate)	96%
Depth of Discharge	90%
Dimension (W*D*H mm)	803*845*2130
Weight(kg)	1228
Design Life	15+Years
Operation Temperature ()	10~40
Humidity	5%~95%
Altitude	2000
Battery Module Qty.(Optional)	1~19 pcs
Authentication level	IEC62619/CE/UN38.3

Powercube M3
100~1400V



Basic Parameters	Powercube-M3A-100 (729.6V148Ah)	Powercube- M3A-180 (1113.6V148Ah)
Battery Module	HM3A100	HM3A180
Battery System Capacity(kWh)	107.98	164.81
Battery system Voltage(V)	729.6	1113.6
Battery System Voltage Range (V)	615.6~820.8	939.6~1252.8
Efficiency(@0.5C-rate)	96%	96%
Depth of Discharge	90%	90%
Dimension (W*D*H mm)	803*845*2130	1185*845*2130
Weight(kg)	1228	1798
Design Life	15+Years	15+Years
Operation Temperature ()	10~40	10~40
Humidity	5%~95%	5%~95%
Altitude	2000	2000
Battery Module Qty.(Optional)	1~19 pcs	1~29 pcs
Authentication level	UL1973/IEC62619 /UL9540A/CE/UN38.3	IEC62619/VDE2510-50 /CE/UN38.3

SPECIFICATION

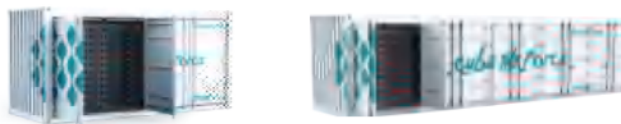

Basic Parameter	20ft High Voltage System Container		40ft High Voltage System Container	
Battery System Type	Powercube-20H-M1		Powercube-40H-M1	
System Charge/Discharge Rate	0.5C		0.5C	
System Voltage Range(V)	736(690~828)		736(690~828)	
System Capacity(kWh)	1296		2592	
Battery System Type	Powercube-20H-M2		Powercube-40H-M2	
System Charge/Discharge Rate	0.5C	0.5C	0.5C	0.5C
System Voltage Range(V)	806(680~907)	1228(1036~1382)	806(680~907)	1228(1036~1382)
System Capacity(kWh)	1432	1454	2983	3273
Battery System Type	Powercube-20H-M3		Powercube-40H-M3	
System Charge/Discharge Rate	0.5~1C	0.5~1C	0.5~1C	0.5~1C
System Voltage Range(V)	806(680~907)	1228(1036~1382)	806(680~907)	1228(1036~1382)
System Capacity(kWh)	1194	1091	2625	2546
Dimension (L*W*H, M)	6.058*2.438*2.896		12.192*2.438*2.896	
Ambient Temperature ()	-2050			
Communication	CANBUS/Modbus TCP/IP			



www.pylontech.com
sales@pylontech.com.cn



Pylon Technologies Co., Ltd
No. 73, Lane 887, Zu Chongzhi Road,
Zhangjiang Hi-Tech Park Pudong,
Shanghai 201203, China

