



# GX GSM manual

rev 01 - 02/2023

This manual is also available in [HTML5](#).

# Table of Contents

<b>1. Introduction</b> .....	<b>1</b>
1.1. General description .....	1
<b>2. Features</b> .....	<b>2</b>
2.1. Built-in GPS receiver .....	2
2.2. GX compatibility .....	2
2.3. SIM card .....	2
2.4. When to use a mobile router instead .....	2
2.5. Antennas and accessories .....	2
2.6. What's in the box? .....	2
<b>3. Installation and configuration</b> .....	<b>3</b>
3.1. Installation step-by-step .....	3
3.2. Configuration .....	4
<b>4. Operation</b> .....	<b>6</b>
4.1. SIM status .....	6
4.2. Status Bar .....	6
4.3. GPS .....	6
<b>5. Troubleshooting</b> .....	<b>7</b>
5.1. Troubleshooting guide .....	7
5.2. What to do if the GX GSM is not staying connected? .....	7
<b>6. Technical data</b> .....	<b>8</b>
6.1. Technical data .....	8
<b>7. Appendix</b> .....	<b>9</b>
7.1. Accessory / Antennas .....	9
7.1.1. Outdoor 2G and 3G GSM Antenna .....	9
7.1.2. Active GPS Antenna .....	9
7.2. Notes regarding regional coverage .....	10
7.3. Dimensions .....	10
<b>8. Warranty</b> .....	<b>11</b>
8.1. Five year limited warranty .....	11

# 1. Introduction

## 1.1. General description



The product described in this guide is replaced by the newer **GX LTE 4G** modem.

The GX GSM only works with 2G and 3G networks, which are slowly being phased out in different countries. Therefore, depending on the installation location, the **GX LTE 4G** can be a more future-proof solution.

The GX GSM is a modem and GPS accessory for our **GX range** of monitoring products. The GX GSM is a cellular modem; providing a mobile internet for the system and connection to the **VRM Portal**. It works on 2G and 3G networks.

There are multiple models, refer to the table below to see which model best matches the available cellular network bands in your region.

Part number	Name	Region*	Used module	Supported 2G (GSM/GPRS/EDGE) frequencies	Supported 3G (UMTS/HSPA+) frequencies
GSM100100100	GX GSM 900/2100	Europe, Asia, Australia, Middle East, Africa	SIMCom SIM5360E	850/900/1800/1900 MHz (Quad-Band)	900/2100 MHz (Dual-Band)
GSM100200100	GX GSM 850/1900	United States, Canada, Mexico and most countries of S. America	SIMCom SIM5360A	850/900/1800/1900 MHz (Quad-Band)	850/1900 MHz (Dual-Band)

\* In case of uncertainty please double-check: [GSM World Coverage Map](#)

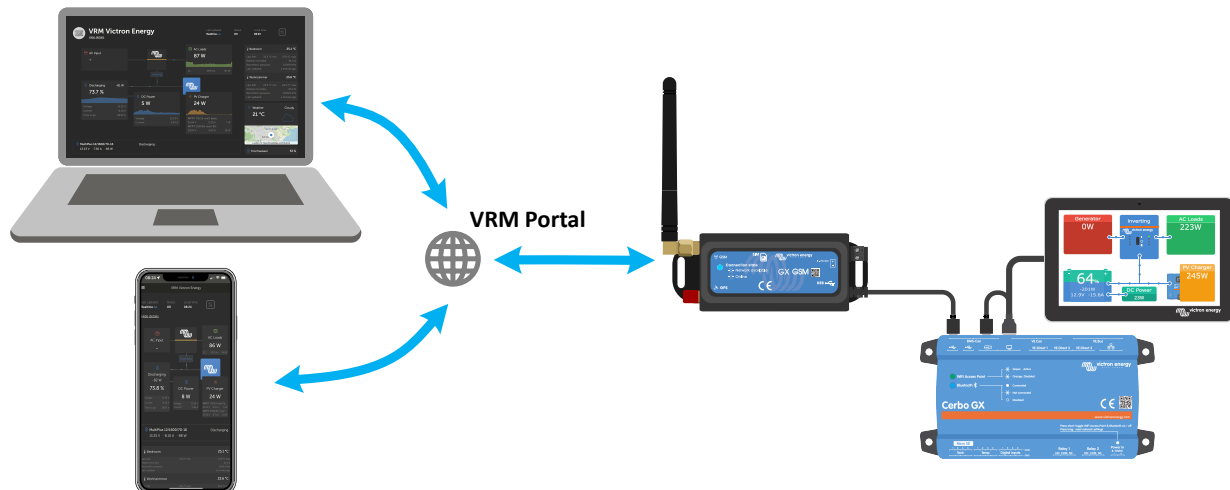

## 2. Features

### 2.1. Built-in GPS receiver

The GX GSM includes a built-in GPS receiver. When the optional active GPS antenna is installed, the system can be tracked as well as geo-fenced on the VRM Portal.

The required accessory part number is GSM900200100 - Active GPS Antenna for GX GSM.

### 2.2. GX compatibility

The GX GSM can be used with any of the GX devices and requires Venus OS v2.22 or newer to be installed on the GX device.

### 2.3. SIM card

It requires a SIM card of the [Mini-SIM format](#) and connects to the GX device with an included 1m USB cable.

### 2.4. When to use a mobile router instead



The GX GSM provides an internet connection for the GX device only. There is no option to share the internet to laptops, phones, or other devices.

For installations where more devices need internet, such as a yacht or RV, consider installing a mobile router instead.

### 2.5. Antennas and accessories

A small indoor GSM antenna is included. Optionally, we also sell an outdoor outdoor 2G and 3G GSM antenna, which increases the range:

- Part number GSM900100100 - Outdoor 4G GSM Antenna

### 2.6. What's in the box?

- GX GSM (with integrated USB cable)
- GSM mini rod antenna (for indoor use)
- DC power cable (with inline fuse and terminal block)

## 3. Installation and configuration

### 3.1. Installation step-by-step

Follow the steps below to install the GX GSM:

1. Mount the device in a place that is not covered by metal objects. Consider using the optional outdoor antenna when installing the GX GSM in a closed metal enclosure, car, or van to increase the range.
2. Mount the supplied antenna to the SMA connector marked GSM or connect an optional external outdoor antenna if required.
3. An optional active GPS antenna is screwed onto the SMA connector labeled GPS.
4. Insert the SIM card. You will need to eject the SIM card tray with a pen or other pointy object. Be aware that the SIM card tray sits slightly recessed inside the unit. Be sure to push it all the way in.
5. Connect the GX GSM to the GX device with the supplied USB cable. Use a USB hub if all USB sockets are already in use.
6. Connect the DC power supply (8 to 70 VDC). A 1.4 m cable with M10 cable lugs and a built-in Slow Blow fuse 3.15A 250V, 5x20mm is included. Pay attention to the correct polarity as labeled on the front sticker.
7. After power-up, the blue LED will be solid blue. Once it has registered on a network, the LED will start blinking slowly. Finally, when the internet connection is established, the LED will blink quickly.

## 3.2. Configuration

The GX GSM is configured entirely via the connected GX device.

Setting a SIM-PIN helps reducing the risk of the SIM card being stolen and used. Use a mobile phone to set the SIM-PIN, and thereafter configure it on the GX device as follows:

1. When using a SIM card with its SIM-PIN security disabled, the system will work without further configuration.

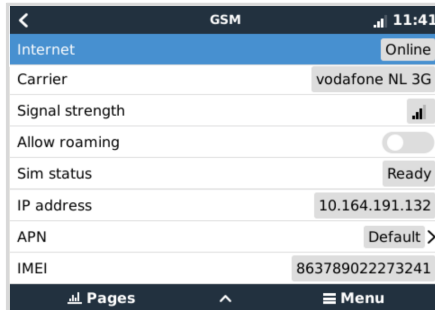

2. Setting a SIM-PIN helps reducing the risk of the SIM card being stolen and used. Use a mobile phone to set the SIM-PIN, and there after configure it on the GX device as follows:

Go to Settings → GSM modem → PIN.

3. Enter the same PIN that was previously set in the mobile phone or provided by the network operator.

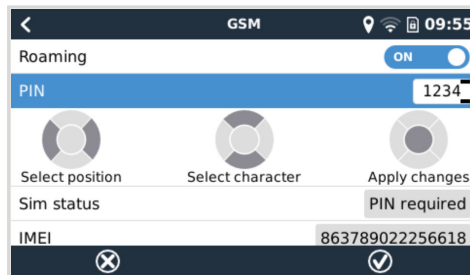

4. Go to Settings → GSM Modem → APN and set the APN name if necessary. Some mobile networks require manual configuration of an APN especially when roaming. Contact your network operator for details.

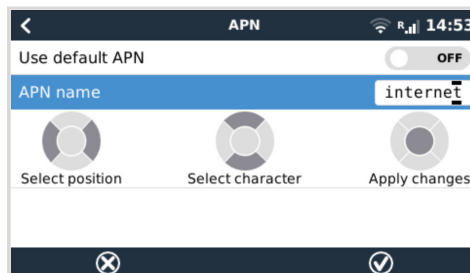

5. If you are installing the GX GSM in an area where you can expect internet coverage to be occasionally disrupted, you should enable the “Reboot device when no contact” option in the GX device’s VRM menu. This will automatically restart the GX device and power cycle the GX if it has failed to transmit data to VRM for the configured time.

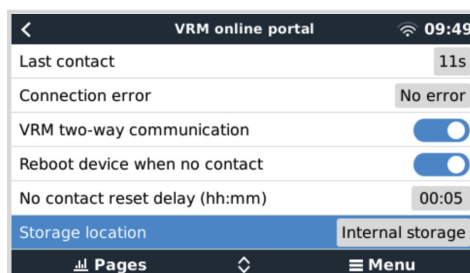



Note that if you are leaving internet service coverage areas (such as an RV on the move, or a boat leaving dock to go to sea), then it is recommend to disable this setting, so that your GX is not rebooting itself for no reason. Or set it, for example, to a two hour time-out and accept a reboot every two hours when underway.

Watch this video to learn how to connect via LAN, WiFi and the GX GSM: [Connecting a Victron GX Device online and setting up a GX GSM](#)

## 4. Operation





### 4.1. SIM status

The SIM status is displayed on the GSM overview page on the GX device. The following table shows all possible states and their meaning:

Status	Description
Ready	SIM card is installed properly and registered to the network.
SIM not inserted	SIM card is missing or not inserted properly. SIM tray might hang out a little.
PIN required	SIM card requires a 4 digit PIN for unlock.
PUK required	SIM is locked due to wrong PIN inputs. 8 digit PUK is required to release the lock state.
SIM failure	SIM does not respond - might be broken.
SIM busy	SIM is in busy state.
SIM wrong	Type of SIM is not supported.

### 4.2. Status Bar

GSM modem status can be checked at a glance by looking at the status bar.

Icon	Details
	GSM modem is connected to network, but not to the internet (no data connection). Possibly on purpose, because an Ethernet or WiFi connection is available.
	GSM modem is properly configured, the 3G/EDGE etc. icon reflects that the cellular modem internet connection is in use and what type of connection is applied.
	WiFi is available and its internet connection is in use. WiFi has priority over GSM connection.
	SIM-PIN code is required.
	Roaming, only informative. To use internet connection while roaming, it needs to be enabled in Settings → GSM modem → Allow roaming.

### 4.3. GPS

When the optional active GPS antenna is added, the position is sent to the VRM portal and also displayed in the GX device as follows:

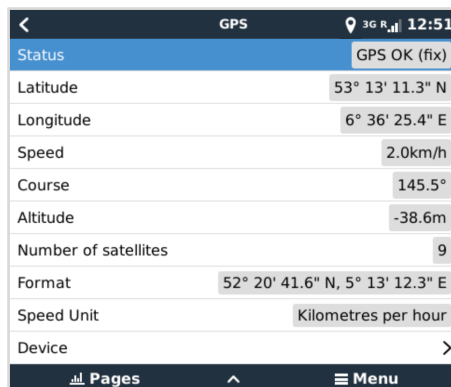

GPS	
Status	GPS OK (fix)
Latitude	53° 13' 11.3" N
Longitude	6° 36' 25.4" E
Speed	2.0km/h
Course	145.5°
Altitude	-38.6m
Number of satellites	9
Format	52° 20' 41.6" N, 5° 13' 12.3" E
Speed Unit	Kilometres per hour
Device	>



## 5. Troubleshooting

### 5.1. Troubleshooting guide

There are many reasons for a modem internet connection to not work. Carefully go through each step of this troubleshooting guide. Make sure to start at the first step. When asking for help, make sure to mention each step taken and the result.

Step	Element	Details
1	Power	Check that the blue LED is either lit continuous or blinking.
2	USB connection	The modem must be connected to USB, and visible in the Settings → GSM modem menu.
3	SIM card status	Check the SIM Status in the menu, it must show "Ready". It will show "SIM not inserted", or "PIN required", or "PUK required" and more related errors when there is a problem. Please refer to the <a href="#">SIM status list</a> for details.
4	Signal strength	1 bar minimum for VRM logging, 2 or 3 bars are necessary for a working remote console. An outdoor antenna typically increases received signal by 15 dB to 25 dB.
5	Carrier registration	Check that a name of a Cellular provider is visible in the "Carrier" field. If it is not, check signal strength and otherwise contact your SIM card provider and/or insert the SIM card in a phone to double check its operation and subscription status.
6	Internet connection	Verify that the Internet shows "Online". Reasons for the system to not go "Online" whilst properly registered on the Network are: 1) APN not configured, contact the network operator for details. 2) The network is a different one than the home network (ie. roaming), and the setting to permit Roaming is disabled. 3) Signal strength is strong enough to register on the network, but not to open the data connection to the internet.
7	Connection to VRM portal	Verify that the VRM Portal menu shows a recent last connection time. See Settings → VRM Portal. For more details, see the <a href="#">VRM Connection troubleshooting chapter of the GX Manual</a> .



Note that Ethernet and WiFi connections have priority over the cellular connection. Even when the available Ethernet or WiFi connection does not have a good connection to the internet, there is no automatic detection in place which in such case switches over to the GX GSM. In more technical language: when the cellular data connection is active, it is configured with a high routing metric. This way, the Linux kernel prioritises Ethernet or Wifi when these are available.

### 5.2. What to do if the GX GSM is not staying connected?

Enable the "Reboot device when no contact" configuration setting in the VRM menu of the GX device. That will reboot the GX (and with it the GX GSM) automatically if the internet connection is not available. See also the [configuration chapter \[4\]](#) for more details.

## 6. Technical data

### 6.1. Technical data

GX GSM	GSM100100100   GSM100200100
Supply voltage range	8 - 70VDC
Power draw	2.5W while 2G/3G data transfer <1.0W in idle mode +0.4W if GPS is enabled
Operating temperature range	-40 +50°C (-40 - 120°F)
Power cable (included)	1.4m cable with inline fuse holder, terminal block and 10mm ring terminals
Inline fuse (included)	T3.15A250V
<b>COMMUNICATION</b>	
USB communication port	Fixed 1.0m cable with USB-A connector (connects to the GX device)
LTE antenna connector	Type SMA Female (optional Outdoor 2G and 3G GSM antenna GSM900100100)
GPS antenna connector	Type SMA Female (optional GPS antenna GSM900200100)
GNSS	GPS/Beidou/GLONASS/GALILEO/QZSS
SIM card	Regular Mini SIM (supports both 1.8V and 3V)
Data transmission (max. Download/ Upload)	3G (HSPA+): 42 Mbps / 5.76 Mbps 2G (EDGE): 236.8 Kbps / 236.8 Kbps 2G (GPRS): 85.6 Kbps / 85.6 Kbps
Status indicator	Blue LED
<b>INSTALLATION &amp; DIMENSIONS</b>	
Dimensions (l x w x h)	106 × 42.5 × 22mm
Weight	0.08kg (0.177lbs)
Wire gauge (power cable)	0.5..1.5mm <sup>2</sup> / AWG 28..16 or use supplied power cable
Recommended fuse size	500mA @ 12V / 250mA @ 24V / 100mA @ 48V or use supplied inline fuse
<b>STANDARDS</b>	
Safety	EN 60335-1 / EN 60335-2-29 / EN 62368-1
Emission / Immunity	ECE R10-5
QM	EN 9001:2015

## 7. Appendix

### 7.1. Accessory / Antennas

#### 7.1.1. Outdoor 2G and 3G GSM Antenna



This antenna can be used with the GX GSM for 2G and 3G bands.

<b>Part number</b>	GSM900100100
<b>Mounting option</b>	Screw mount
<b>Cable type</b>	RG-316
<b>Cable length</b>	3.0 m
<b>Connector</b>	SMA Male straight
<b>Frequencies</b>	800/900/1800/1900/2100 MHz
<b>Signal Gain</b>	3 dBi

#### 7.1.2. Active GPS Antenna



<b>Part number</b>	GSM900200100
<b>Mounting option</b>	Magnet
<b>Cable type</b>	RG-74
<b>Cable length</b>	3.0 m
<b>Connector</b>	SMA Male straight
<b>Frequencies</b>	1575.42 MHz
<b>Impedance</b>	50 $\Omega$

## 7.2. Notes regarding regional coverage

A good reference to check frequencies is [4G world Coverage Map](#). Note that the page also contains 2G and 3G information, which is on its GSM World Coverage link on the top.

**USA, Mexico, Canada and most of South America:** 1900 MHz is the most common frequency for 3G, which is unsupported for this version of GX GSM. Use the [GX LTE 4G](#) instead.

**Australia:** The 900 MHz 3G frequency in remote areas is typically provided by Optus. Telstra's rural 3G network operates at 850 MHz, which is not supported with the current version of GX GSM. Both Telstra and Optus operate 2100 Mhz networks in urban areas, and are supported.

## 7.3. Dimensions

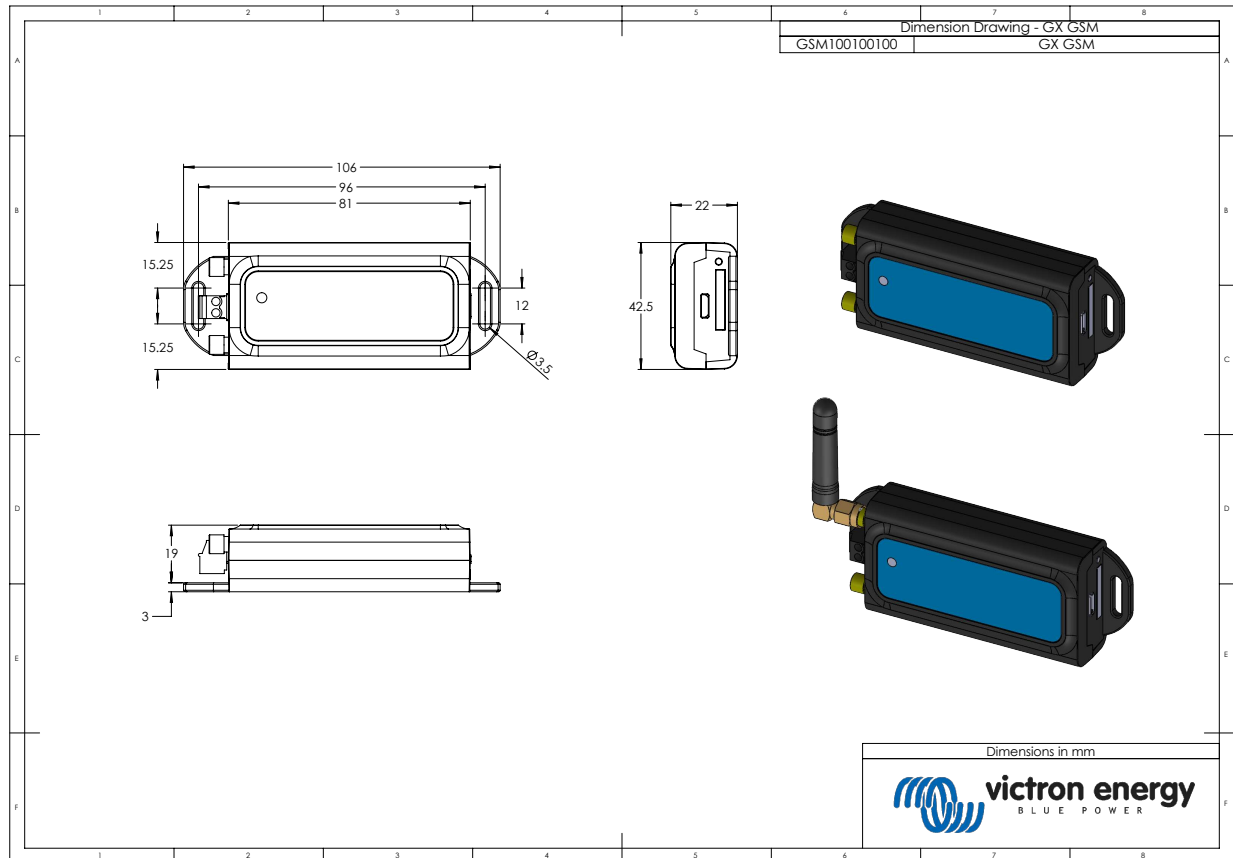

## 8. Warranty

### 8.1. Five year limited warranty

This limited warranty covers defects in materials and workmanship in this product and lasts for five years from the date of original purchase of this product.

The customer must return the product together with the receipt of purchase to the point of purchase.

This limited warranty does not cover damage, deterioration or malfunction resulting from alteration, modification, improper or unreasonable use or misuse, neglect, exposure to excess moisture, fire, improper packing, lightning, power surges, or other acts of nature.

This limited warranty does not cover damage, deterioration or malfunction resulting from repairs attempted by anyone unauthorized by Victron Energy to make such repairs.

Victron Energy is not liable for any consequential damages arising from the use of this product.

The maximum liability of Victron Energy under this limited warranty shall not exceed the actual purchase price of the product.